

HN1816

Drawn cup needle roller bearing open end

Schaeffler ID:
0000368540000

Drawn cup needle roller bearings with open ends HN, full complement needle roller set

Technical information

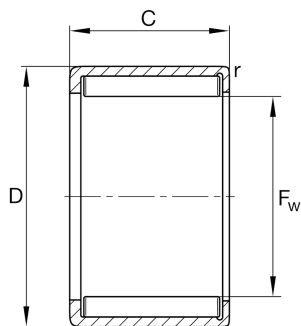

Main Dimensions & Performance Data

F_w	18 mm	Under roller diameter
D	24 mm	Outside diameter
C	16 mm	Width, outer ring
C_r	17,000 N	Basic dynamic load rating, radial
C_{0r}	32,500 N	Basic static load rating, radial
C_{ur}	4,350 N	Fatigue load limit, radial
$n_{G \text{ Grease}}$	6,000 1/min	Limiting speed for grease lubrication
n_{gr}	8,000 1/min	Reference speed
	20 g	Weight

Dimensions

r_{\min}	0.8 mm	Minimum chamfer dimension
------------	--------	---------------------------

Temperature range

T_{\min}	-30 °C	Operating temperature min.
T_{\max}	140 °C	Operating temperature max.

Additional information

IR15X18X16-XL	Suitable inner rings IR
LR15X18X16,5	Suitable inner rings LR